

Toner Density/Quantity Sensors

Permeability sensing type

TS series

Type: **TS-L(Double-sided substrate type)**
 TS-A(One-sided substrate type)
 TS-K(One-sided substrate type)

Issue date: February 2007

- All specifications are subject to change without notice.
 - Conformity to RoHS Directive: This means that, in conformity with EU Directive 2002/95/EC, lead, cadmium, mercury, hexavalent chromium, and specific bromine-based flame retardants, PBB and PBDE, have not been used, except for exempted applications.
-

Toner Density/Quantity Sensors

TS-L, -A, and -K Series

Conformity to RoHS Directive

Plain paper copiers and laser printers require the toner (pigment powder) and carrier (magnetic powder) to be mixed in the proper proportions to create the developer.

FEATURES

- The TS-L, TS-A and TS-K toner sensors use a high performance ferrite core differential transformer with an adjustable control lead wires. When the DC voltage applied to the control lead wires is varied, the sensor working point also varies. Since the control lead wires (and working point) can be set to practically any desired value, it provides the following capabilities:
- The sensor adjustment point can be installed at any location most convenient for operation.
- Because it has such a wide control range, the working point can be reset easily after changing the developer, or whenever needed.
- The microprocessor in the printer or copier can vary the control lead voltage for automatic adjustment.
- In multi-color printers, it is no longer necessary to use a different constant sensor for each color. One TDK programmable toner sensor can accommodate the working point differences of each color toner with easily adjustable control voltage.
- The compact size of the sensors makes them easy to install in virtually any locations.

ELECTRICAL CHARACTERISTICS









Power supply	
Rated input voltage E _{dc} (V)	24±5%
Power supply input current(mA)	20max.
Control input	
Rated control input voltage E _{dc} (V)	7
Control input current(mA)	10max.
Control input voltage range E _{dc} (V)	2 to 24
Control input impedance(MΩ)	1±10%
Analog output characteristics	
Output voltage B(V)	2±0.2 [at normal temperature and humidity]
Output voltage A(V)	3.3±0.3 [at normal temperature and humidity]
Output variable range ΔB(V)	1min.[V _c :by change of 2V]
Output impedance (kΩ)	150±10% at DC
Output filter time constant (s)	1max.
Output ripple E _{p-p} (mV)	20max.
Temperature change(V)	±0.5 max.[at 0 to +50°C, change from 25°C]
Digital output characteristics	
Digital output voltage:H (V)	4.5min.
Digital output voltage:L(V)	0.5max.
Digital output current:H(mA)	0.4max.
Digital output current:L(mA)	0.5max.
Level comparator threshold voltage (V)	2.5±0.5[Analog output voltage]

- The value shown above are the adjusted value of programmable toner sensors TS0524LB-X.

The TDK programmable toner sensor has been developed to constantly maintain the correct mix ratio between them, which is capable of keeping an optimum status by using a DC output voltage corresponding to the mix ratio.

PRODUCT IDENTIFICATIONS









A AND K SERIES (ONE-SIDED SUBSTRATE TYPE)

TS       -   

(1) (2) (3) (4) (5) (6) (7) (8)

- | | |
|--------------------------------|--------------------------------------|
| (1) Series name | (6) Sensor's shape |
| (2) Internal operation voltage | A: L type |
| Standard 05: 5V | (sensing diameter: ø10mm) |
| (3) Power supply voltage | K: Compact type |
| Standard 24: 24V | (sensing diameter: ø8mm) |
| (4) Analog output | (7) Specification continuous number* |
| A: Analog output "Yes" | (8) Manufacturing internal code* |
| N: Analog output "No" | C: Connector type |
| (5) Digital output | E: Empty sensor, etc. |
| D: Digital output "Yes" | * (7) and (8): TDK's internal code |
| N: Digital output "No" | |

L SERIES (DOUBLE-SIDED SUBSTRATE TYPE)

TS      -   

(1) (2) (3) (4) (5) (6) (7)

- | | |
|--------------------------------|--------------------------------------|
| (1) Series name | (5) Sensor protrusion length(L) |
| (2) Internal operation voltage | A: 3.0mm |
| Standard 05: 5V | B: 4.5mm |
| (3) Power supply voltage | (6) Specification continuous number* |
| Standard 24: 24V | (7) Manufacturing internal code* |
| (4) Sensor construction | C: Connector type |
| L: TH core type | E: Empty sensor, etc. |
| | * (6) and (7): TDK's internal code |

- Conformity to RoHS Directive: This means that, in conformity with EU Directive 2002/95/EC, lead, cadmium, mercury, hexavalent chromium, and specific bromine-based flame retardants, PBB and PBDE, have not been used, except for exempted applications.

- All specifications are subject to change without notice.

SHAPES AND DIMENSIONS
ONE-SIDED SUBSTRATE TYPE
A SERIES

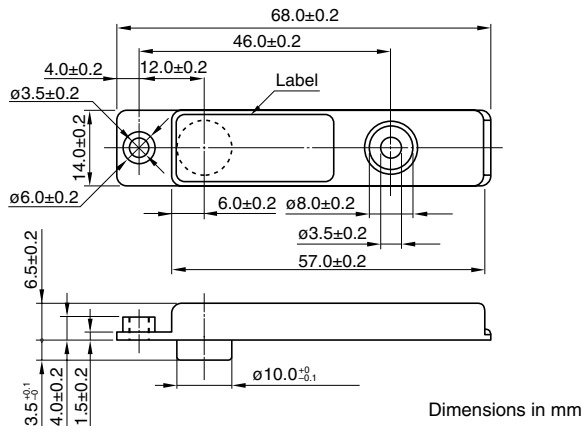

DOUBLE-SIDED SUBSTRATE TYPE
L SERIES

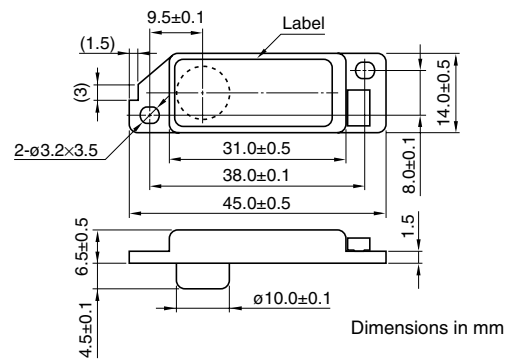

K SERIES

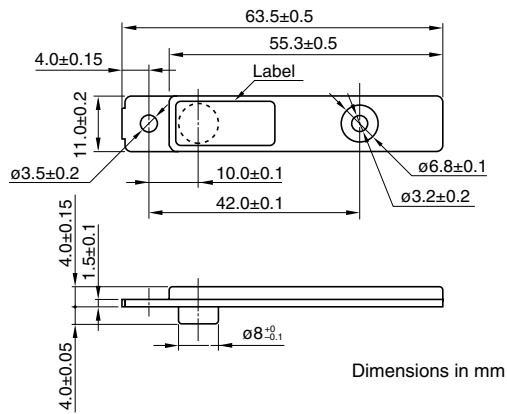

• All specifications are subject to change without notice.

TO ADJUST WORKING POINT

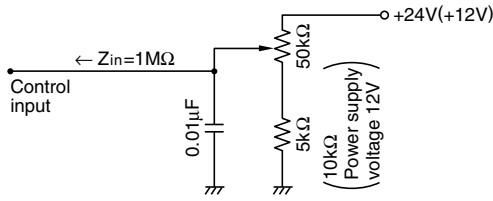

TO ADJUST DIGITAL OUTPUT THRESHOLD VOLTAGE

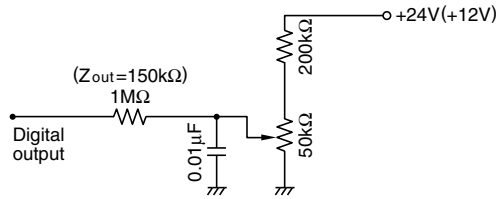

TO INCREASE ANALOG OUTPUT FILTER TIME CONSTANT

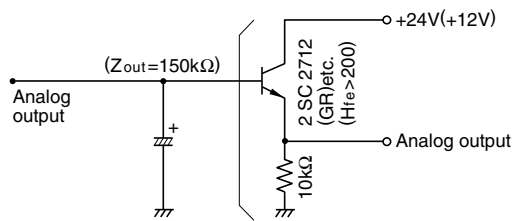

TO BUFFER DIGITAL OUTPUT

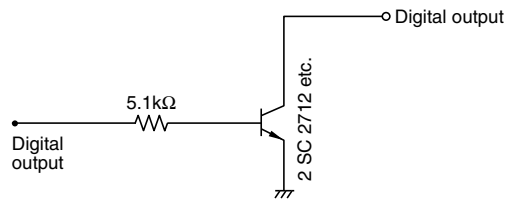

TO SWITCH WORKING POINT

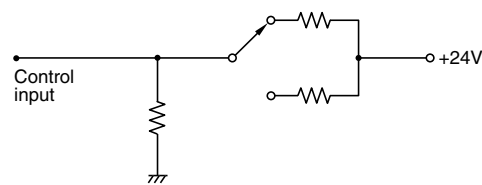

TYPICAL CHARACTERISTICS

TONER DENSITY vs. TYPICAL OUTPUT CHARACTERISTIC

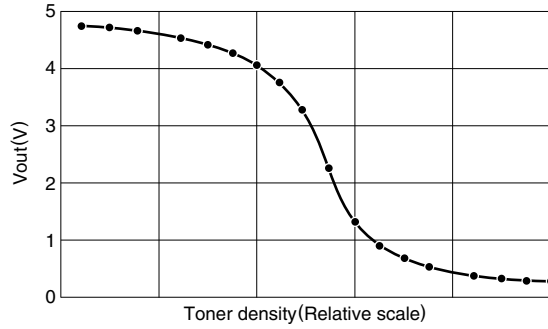

CONTROL VOLTAGE vs. TYPICAL OUTPUT CHARACTERISTIC

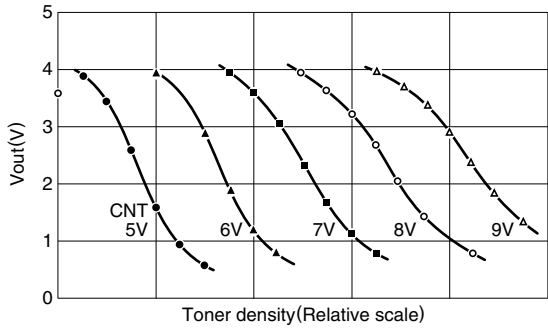

TYPICAL TEMPERATURE CHARACTERISTIC

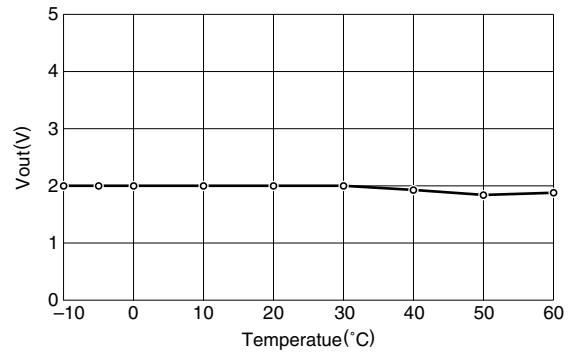

TYPICAL HIGH TEMPERATURE AND HIGH HUMIDITY LOAD TEST

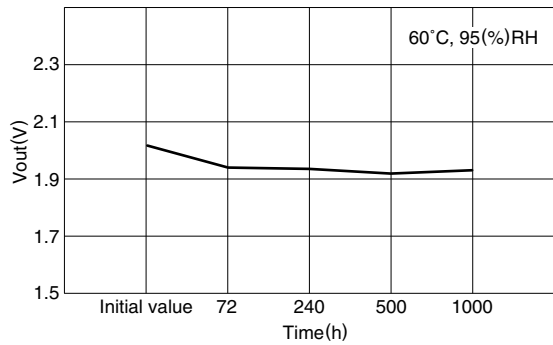

PRECAUTIONS

Adhere to the following recommendations to ensure stable operation of the programmable toner sensor.

Values shown here are guidelines for general design. Detection sensitivity of sensors is influenced by the material and shape of the developer container that the sensor will be used with, and the mechanism for carrying the developer. Refer to separate documents for special design specifications.

1. The quantity of developer (toner carrier) around the sensor face

The detection sensitivity will drop when the quantity of developer around the sensor face (D in the diagram below) is low (below 5mm). Increasing the sensitivity of the sensor itself through the circuiting can compensate for this. However, as sensor sensitivity increases, environmental and temperature resistance characteristics deteriorate, causing decreased stability of operation. Design the developer container and the mechanism for carrying the developer so that there is a minimum of 6mm (D in the diagram below).

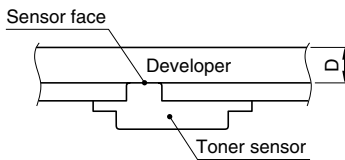

2. Influence of an external magnetic field near the sensor

If a DC magnetic field is applied near the sensor, the sensors working point will need to be changed correspondingly.

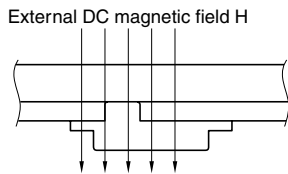

If the DC magnetic field strength changes depending on the individual device, the working point of the sensor will need to be reset depending on the DC magnetic field. The best environment is one where there is no DC magnetic field. However if this is unavoidable on designing, please contact us.

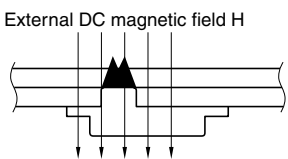

If the DC magnetic field is strong, it may be necessary to use the TS-M series possessing a magnetic shield core, or the highly sensitive TS-H series with a large core for the sensor coil. As shown in the diagram above, however, the carrier that is in the developer may become trapped over the core, impairing the performance of the sensor. (The TS-L series uses a small core so this situation rarely occurs.)

3. Influence of conductive material near the sensor

A conductive material placed near the sensor can also change its working point. If a certain distance is kept between them, normal operation can be recovered by resetting the working point. However, if the conductor is quite close to the sensor, as in the diagram below, the adjustment range for the working point may be exceeded.

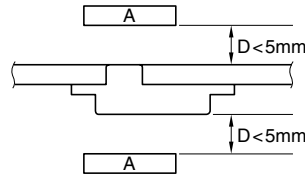

A: Conductors such as aluminum plates

If the sensor is installed on a conductor such as aluminum, it may not function at all since the driving power of the sensor coil will be shorted. The custom types can be installed on conductive surfaces, but the working point adjustment will vary widely from installation to installation due to the close relationship between the mounting and the fluctuation margin of the working point. This complicates adjustment procedures.

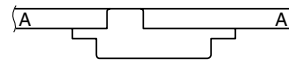

A: Conductors such as aluminum plates

If the application requires installing a sensor on aluminum, working point changes can be reduced first by placing a plastic plate of at least $\phi 30\text{mm}$ in diameter over the aluminum. Even with this method, some variability in working point can be expected.

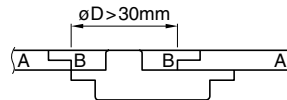

A: Conductors such as aluminum plates
B: Non-conductive material such as plastic

4. Causes of ripple of detection output

Ripple in the output detection occurs when the flow rate of developer around the sensor is unstable. Depending on the size of the ripple, this can considerably lower control accuracy. For this reason it is best to locate the sensor where the flow of developer is smooth. The sensor itself contains a built-in filter for absorbing ripples, so there are generally no problems with a normal level of ripple. However if the size of the ripples exceed ordinary levels, difficulties such as those describe below may occur.

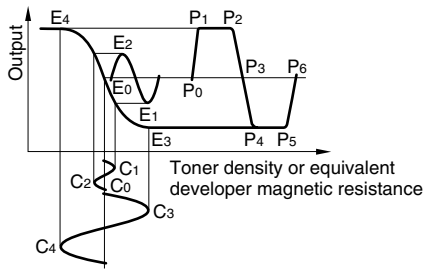

The above illustration is a model of how unstable developer flow leads to ripple in the detection output. If there is a comparatively small fluctuation in developer flow ($C_0 \rightarrow C_1 \rightarrow C_0 \rightarrow C_2 \rightarrow C_0$) around the working point C_0 , this will be reflected in an output ripple between E_1 and E_2 . As long as the fluctuation in the output ripple remains within the developer working range, the output signal filtering is sufficient to ensure stable sensor characteristics. However, if the flow of developer fluctuates in a more unstable pattern, such as $C_0 \rightarrow C_3 \rightarrow C_0 \rightarrow C_4 \rightarrow C_0$, the sensor saturation range may be exceeded as shown by the output ripple peaks E_3 and E_4 . In this case sensing only takes place from P_0 to P_1 , P_2 to P_3 , and P_5 to P_6 . Sensing does not take place between P_1 to P_2 , or P_4 to P_5 due to saturation. Sensitivity is greatly reduced because of this. It is possible of course to reduce the ripples through filtering. However, saturation reduces the sensitivity of the sensor itself. In order to maintain the same high level of sensitivity as when there are only small ripples below saturation levels after filtering, the sensitivity needs to be increased in advance. Unfortunately, increasing the sensitivity (increasing the sensitivity to changes in the flow of developer), leads to a larger output ripple. Not only this, but as the S/N ratio does not change when sensitivity is increased, there is no increase in control accuracy, and sensor environmental characteristics are impaired as well, resulting in even more unstable sensing.

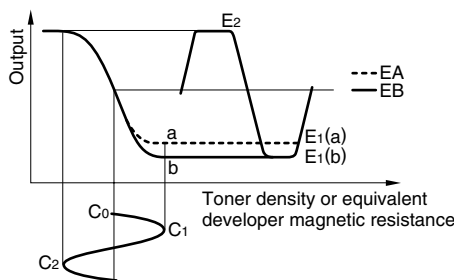

The following is another reason for avoiding large ripples. The previous diagram shows an extremely unstable case where the developer flow fluctuates between C_1 and C_2 . In this model, two sensors, A and B are installed. Apart from having different saturation points they are identical sensors. "a" is the saturation point for sensor A, and "b" is the saturation point of sensor B. With flow fluctuating as shown ($C_0 \rightarrow C_1 \rightarrow C_0 \rightarrow C_2 \rightarrow C_0$), there will be two output ripples, $E_1(a)$ to E_2 , and $E_1(b)$ to E_2 . After filtering, the average output EA and EB are of course different.

What this model shows is that two sensors with the same characteristics in the working range before reaching saturation, have different outputs when there is a large ripple, causing further problems with the sensitivity of the sensors. With a large ripple, sensitivity must be adjusted individually in order to keep the output level and sensitivity of each sensor the same. This is obviously an extremely difficult task.

These indicate that the problem of output ripples is not just a problem of filter characteristics, and the importance of the stable operation of each installation is emphasized.

As TDK programmable toner filters are equipped with a built-in filter, any ripples that appear in sensor output are what is left after filtering.

When designing the developer container it is best to temporarily remove the sensor filter so that you can view the ripples directly influenced by developer instability.

5. Relation between sensor sensitivity and sensor output voltage.

TDK programmable toner sensors are set with an output center value of 2.5V for the purposes of compatibility with other applications. When the output center values of 2.5V and 5V are compared however, the 5V type has around two times the output voltage fluctuation of the 2.5V type, for the same toner density fluctuation. This shows that the 5V version has around half the sensitivity of the 2.5V version, at the same V/wt%. So the 5V type has far better environment resistance characteristics than the 2.5V type. In view of these things, the 5V type is recommended when designing a new installation.

BASIC OPERATING PRINCIPLES (DIFFERENTIAL TRANSFORMER TYPE TONER DENSITY/QUANTITY LEVEL SENSORS)

1. OPERATING PRINCIPLE

A toner sensor detects a toner density or residual quantity of magnetic developer. The developer is a magnetic material and a magnetic resistance is high if there is a small quantity of magnetic developer and contrarily it is low if there is a large quantity of magnetic developer.

While the toner density or quantity is obtained by detecting a magnitude of the magnetic resistance of the developer, a magnetic resistance variation is very small, thus requiring some feature designed for the detection.

1-1. Detecting principle with differential transformer type sensor

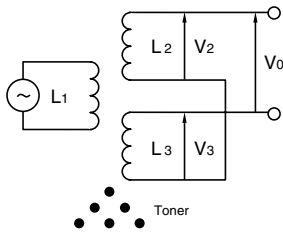

The above illustration 1-1 shows a principle diagram of a differential transformer. The differential transformer has a driving coil L₁, a detecting coil L₃, and a basic coil L₂ in an identical core. Driving the L₁ at a high frequency (500kHz) causes a differential output V₀ equal to V₂ minus V₃ ($V_0 = (V_2 - V_3)$). Assuming that V₃₀ and V₂₀ are output voltages of the detecting and basic coils at a standard density or residual quantity and designing the transformer so that V₃₀ equals V₂₀, the following is obtained for a detecting coil output variation ΔV_3 caused by a density/quantity variation, by which a minute variation ΔV_3 is directly obtained as a differential output:

$$V_0 = V_{20} - (V_{30} + \Delta V_3) = -\Delta V_3$$

In case of normal developer, however, ΔV_3 is approx. 0.1V for a toner quantity variation of 10g around the sensor face and therefore a DC amplifier of 10 magnifications or so is required to detect it as a voltage variation, thus significantly lowering a stability of the sensor. As a means for taking an output variation without losing the stability, there is a method of discriminating a phase instead of discriminating ΔV_3 as a voltage.

1-2. Differential transformer type sensor with phase discriminating method

While the basic coil output V₂₀ and the detecting coil output V₃₀ at the standard density/quantity are set so that V₃₀ equals V₂₀ in order to obtain the sensor output ΔV_3 in the previous section, they are set to obtain the following relation in the phase discriminating method:

$$V_{20} > V_{30} \quad (\text{Standard density/quantity})$$

$$V_{20} < V_{30} + \Delta V_3$$

In other words, the following relations are satisfied:

$$V_0 = V_{20} - V_{30} \geq 0 \quad (\text{Density/low quantity or standard density /quantity})$$

$$V_0 = V_{20} - V_{30} - \Delta V_3 < 0 \quad (\text{Density/much quantity})$$

where the phases of the differential output V₀ are opposite to each other with a phase of the standard density/quantity as a boundary between them. With discriminating this phase variation using a phase discriminator, a large voltage output is obtained for a toner density/quantity variation. By slightly shifting a phase of the basic coil output voltage in advance to cause an output variation to be similar to an analog one, the output is adjusted to vary similarly to an analog output as shown in Fig. 1-2.

1-2. Analog output variation by phase discriminator

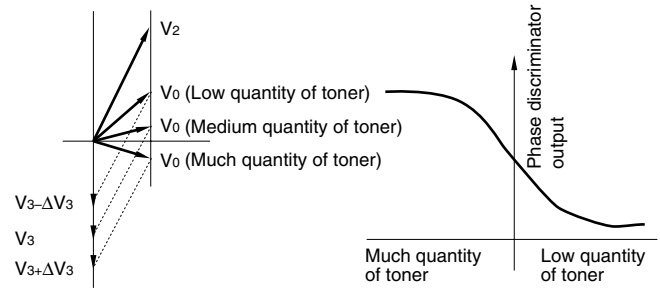

2. CIRCUIT AND OPERATION

In a circuit shown in the below illustration 2-1, an EX-OR gate is used for a phase comparator, an OSC, and a wave shaping circuit:

- An IC1 operates as a Colpitts OSC to drive a driving coil at approx. 500kHz.
- An IC2 operates as a wave shaping inverter to shape a differential output into rectangular waves.
- An IC3 operates as a phase comparator.
- A C1 is a resonance capacitor, which minimize an analog output offset in case of no developer on the sensor face.
- An R1 maintains an appropriate analog output sensitivity.

2-1. Circuit diagram of toner density sensor

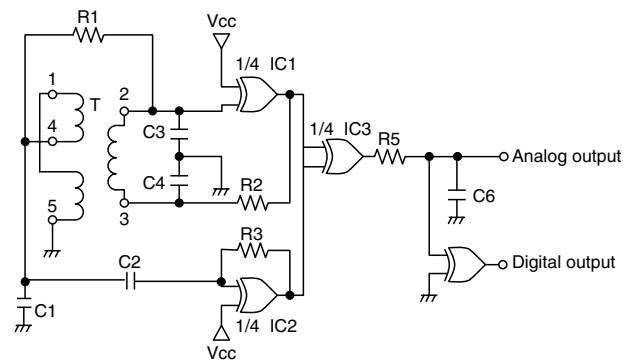

2-2. Signal at each toner density/quantity

